

INDEX

FOREWORD.....	P2
PRODUCT CONTAINS.....	P2
OPTIONAL ACCESSORIES.....	P3
SPECIFICATION.....	P3
FEATURES.....	P4
WARNING and NOTES.....	P5
BATTERIES and MAX CHARGE CURRENT.....	P6-7
SYSTEM SETTING.....	P8
CHARGE/DISCHARGE LIPO BATTERY.....	P9-11
CHARGE/DISCHARGE LIFE BATTERY.....	P12-14
CHARGE/DISCHARGE LIIO BATTERY.....	P15-17
CHARGE/DISCHARGE NIMH BATTERY.....	P18-19
CHARGE/DISCHARGE NICD BATTERY.....	P20-21
CHARGE/DISCHARGE PB BATTERY.....	P22-23
NOTE and REMARK OF WORK STATUS.....	P24
BATTERY IN SERIES CHARGE.....	P25
WARRANTY.....	P26
LIABILITY EXCLUSION.....	P26
CONFORMITY DECLARATION.....	P27
CRC PRODUCT SUMMARY.....	P28

FOREWORD

We thank you for purchasing CRC C6P 10A/100W 110-230V/50Hz AC 11-18V DC balance charger/discharger. For your convenience and safety, please read this manual carefully before using this product.

CRC C6P AC/DC is a professional and high efficiency balance charger/discharger which is especially designed for charging/discharging LiPo , LiFe, Lilo, NiMH,NiCd and PB batteries.

PRODUCT CONTAINS

Below items are included in the package, contact your supplier if any item is miss.

C6P AC/DC Charger x1

AC Input Socket

DC Input Socket

128x64 Pixel LCD Screen

Cooling Fan

Balance Port

Temperature Sensor Port

Multi-Functional Switch
*Select: turn left/right
*Enter/Set: press

Charge Output Socket

AC Input Cable x1

DC Input Cable x1

Charge Cable x1

Balance Socket adapter x1

Instruction Manual x1

We thank you for purchasing CRC C6P 10A/100W 11-18V DC

OPTIONAL ACCESSORIES

Temperature Sensor(magnet) 2x2S in series Adapter 2x3S in series Adapter 2x4S in series Adapter

SPECIFICATION

AC Input voltage range: 110-230V/50Hz
DC Input voltage range: 11.0-18.0V
Charge current range: 0.5-10.0A
Discharge current range: 0.5-5.0A
Maximum charge power: 100W @ 12V DC
Maximum discharge power: 10W
Current drain for balancing: 400mA
Balance accuracy: <10mV
LiPo/Lilo/LiFe battery cell count: 1-6 series
NiCd/NiMH battery cell count: 1-15 series
Pb battery cell count: 1-10 series (2-20V)
Battery setup memories: 10
Temperature sensor: Yes
Weight: 685g
Dimension(LxWxD): 135x145x42mm

FEATURES

- High efficiency power conversion circuit. Special advanced charging technology ensure a fast and precision charging performance.
- The CRC balance charger series has a integrated cell balancer which can be expecially used for charging the LiPo, Lilo, LiFe batteries.
- 10 battery profile memories, 1 default memory of latest profile, 9 custom memories can be set and load by the user.
- 128x64 pixel LCD screen shows rich information: total current, total voltage, charge capacity (mAh), charge time, temperature, cell voltage, cell voltage difference etc.
- Various functional settings can meet a wide range of use. Balance charging-auto, balance charging-manual, normal charging, storage and discharging for Lithium batteries. charging-auto, charging-manual, discharging for NiCd/NiMH batteries. Charging and discharging for Pb batteries.
- Various system settings: backlight, contrast, key sound, safty time, cut off temperature, cut off capacity.
- Full protection system: protection of reversed polarity (input and output), higher/lower input voltage, battery temperature, over charge/discharge and time limited.

WARNING and NOTES

- ▲ C6P is ONLY suitable for charge rechargeable LiPo, LiFe, Lilo, NiMH and PB batteries. Do not attempt to charge dry cells. Charge other types of batteries may cause fire or explosion.
- ▲ Never leave the charger unattended when it is working. If you leave, disconnect the battery to prevent any unexpected dangerous or damage.
- ▲ The prescript DC input voltage range from 11-18V. Never connect it to any other power supply which is unsuitable.
- ▲ Ensure program and settings match the battery pack, incorrect setting to charge/discharge a battery may damage the battery, even would cause a fire.
- ▲ Protect charger from dust, dirt and damp. Do not attempt to disassemble the charger, contact the after sales center for maintenance if needed.
- ▲ Never place the charger and batteries connected to it on any form of flammable surface. Never operate the charger in the vicinity of inflammable material or gas.
- ▲ Ensure that there is an unrestricted airflow to and from the charger's cooling slots.
- ▲ Never charge or discharge any battery having evidence of leaking, expansion/swelling, damaged outer cover or case, color-change or distortion.
- ▲ Take great care to maintain correct battery polarity, and avoid shot-circuit. Read the battery manufacturer's instructions and adhere to them strictly.

BATTERIES and MAX CHARGE CURRENT

Battery Type	No. of Cells	Rated Voltage(V)	Max Charge Current(A)
LiPo	1	3.7	10.0
	2	7.4	10.0
	3	11.1	9.0
	4	14.8	6.8
	5	18.5	5.4
	6	22.2	4.5
LiFe	1	3.3	10.0
	2	6.6	10.0
	3	9.9	10.0
	4	13.2	7.6
	5	16.5	6.1
	6	19.8	5.1
Lilo	1	3.6	10.0
	2	7.2	10.0
	3	10.8	9.3
	4	14.4	6.9
	5	18	5.6
	6	21.6	4.6
NiMH	1	1.2	10.0
	2	2.4	10.0
	3	3.6	10.0
	4	4.8	10.0
	5	6	10.0
	6	7.2	10.0
	7	8.4	10.0
	8	9.6	10.0
	9	10.8	9.3
	10	12	8.3
	11	13.2	7.6
	12	14.4	6.9
	13	15.6	6.4
	14	16.8	6.0
	15	18	5.6
NiCd	Same as NiMH		

SYSTEM SETTING

PB	1	2	10.0
	2	4	10.0
	3	6	10.0
	4	8	10.0
	5	10	10.0
	6	12	8.3
	7	14	7.1
	8	16	6.3
	9	18	5.6
	10	20	5.0
Lipo	Voltage Level: 3.7V/cell Max Charge Voltage: 4.2V/Cell Discharge Voltage Cut off Level: 3.0V/cell or Higher		
LiFe	Voltage Level: 3.3V/cell Max Charge Voltage: 3.8V/Cell Discharge Voltage Cut off Level: 2.0V/cell or Higher		
Lilo	Voltage Level: 3.6V/cell Max Charge Voltage: 4.1V/Cell Discharge Voltage Cut off Level: 3.0V/cell or Higher		
NiMH	Voltage Level: 1.2V/cell Max Charge Voltage: 1.6V/Cell Discharge Voltage Cut off Level: 0.85V/cell or Higher		
NiCd	Voltage Level: 1.2V/cell Max Charge Voltage: 1.6V/Cell Discharge Voltage Cut off Level: 1.0V/cell or Higher		
PB	Voltage Level: 2.0V/cell Max Charge Voltage: 2.45V/Cell Discharge Voltage Cut off Level: 1.75V/cell or Higher		

***Select:** turn left/right
***Enter/Set:** press

STANDBY Menu

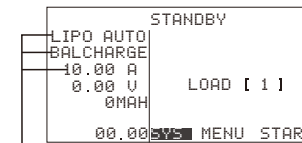

→ **Default memory** (the parameter setting of last work of the charger)

Press "START" charger will directly work under default memory.

Press "LOAD", parameter will change to the memory you load, press "START" charger will work under the setting of the memory.

SYSTEM SETTING

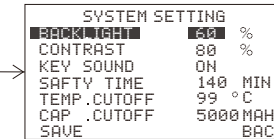

BACKLIGHT:
Range from 0-100%

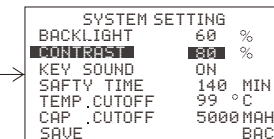

CONTRAST:
Range from 0-100%

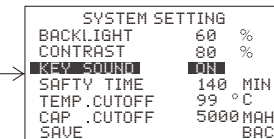

KEY SOUND:
On/Off optional

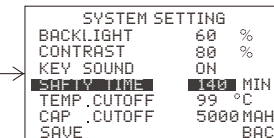

SAFTY TIME:
Charge/discharge time limit, range from 10-990 minutes. Off=no limit.

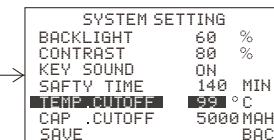

TEMPERATURE CUTOFF:
Battery upper temperature limit. Range from 20-99 °C. Off=no limit.

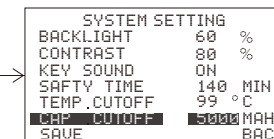

CAPACITY CUTOFF:
Battery capacity protection. Range from 500-9900 mAh. Off=no limit.

CHARGE/DISCHARGE LIPO BATTERY

***Select:** turn left/right
 ***Enter/Set:** press

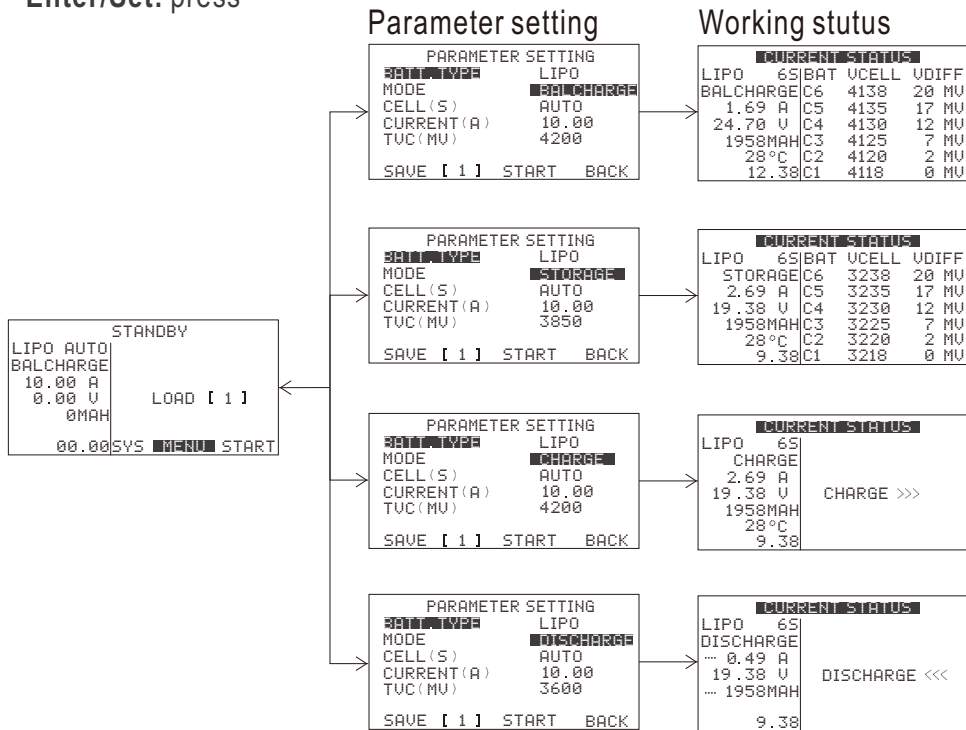

BATT.TYPE

LIPO

MODE

- BALCHARGE:** Balance charge(balance connector required)
- STORAGE:** Storage charge/discharge(balance connector optional)
- CHARGE:** Normal charge (balance connector not required)
- DISCHARGE:** Discharge (balance connector optional)

CELL(S)

AUTO: Can be select in balance charge and storage mode, charger can automatically detect the cell count of the battery.

- 1: Charge/Discharge 1 cell battery(N/A in balance charge mode)
- 2: Charge/Discharge 2 cells battery
- 3: Charge/Discharge 2 cells battery
- 4: Charge/Discharge 4 cells battery
- 5: Charge/Discharge 5 cells battery
- 6: Charge/Discharge 6 cells battery

Important note: In non balance mode, charger can not detect the correct cell count of the battery which has voltage intersection with the other one. So the cell count you set must be exact the same as your battery, otherwise may cause dangerous situation.

CURRENT(A)

Setting the max charge/discharge current. Range from 0.5-10, change unit: 0.5

TVC(MV)

Terminal Voltage Control. Range from 4150-4250, change unit: 10, default: 4200
 (Storage mode range from 3800-3900, default: 3850)

SAVE [1]

Save the current setting to 1st-9th memory.

START

Connect the battery, press start, charger will work under current setting.

BACK

Back to "STANDBY" menu.

CHARGE/DISCHARGE LIFE BATTERY

Working status specify

Balance Charge

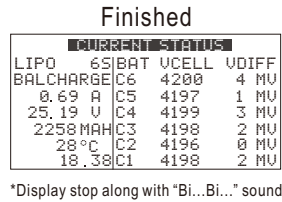
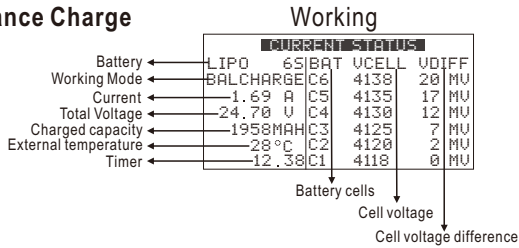

*Display stop along with "Bi...Bi..." sound

Storage

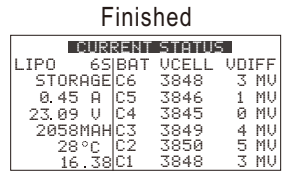
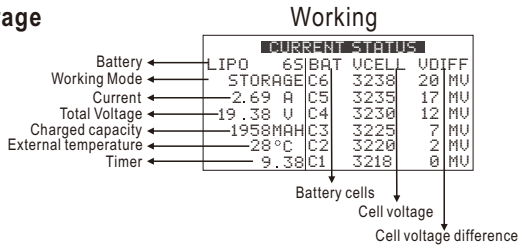

*Display stop along with "Bi...Bi..." sound

Charge

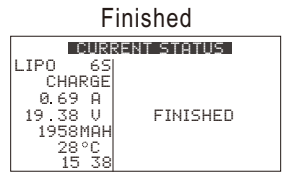
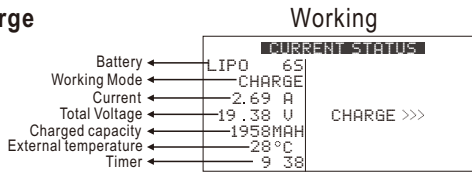

*Display stop along with "Bi...Bi..." sound

Discharge

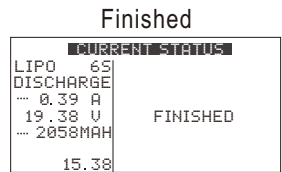
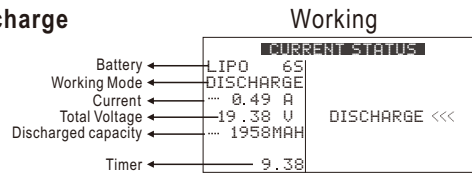

*Display stop along with "Bi...Bi..." sound

*Select: turn left/right

*Enter/Set: press

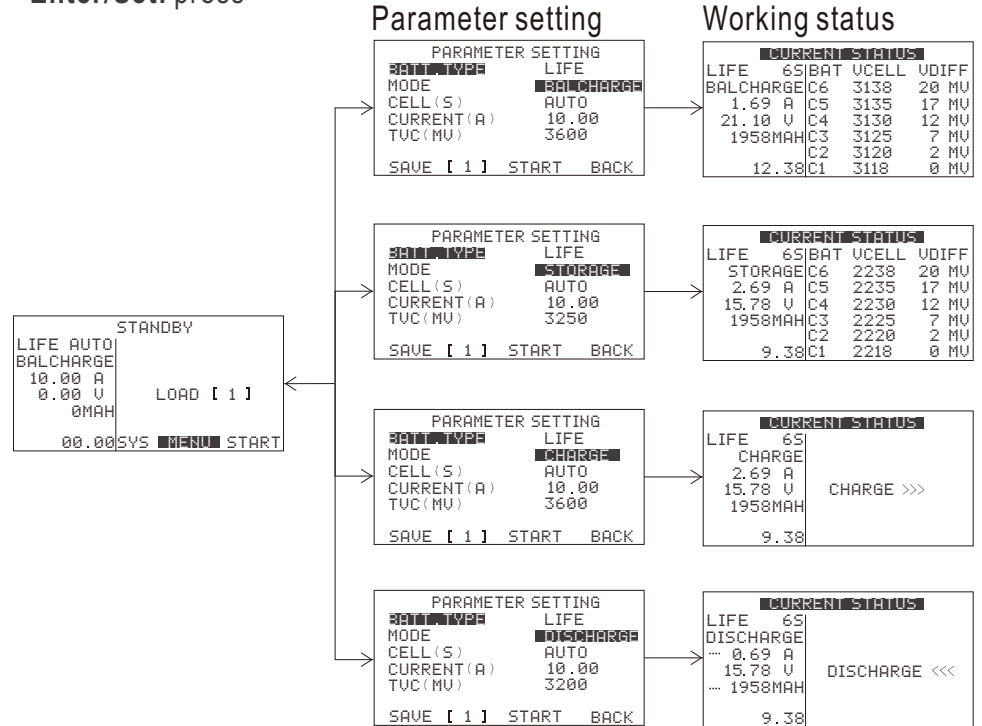

BATT.TYPE

LIFE

MODE

- BALCHARGE:** Balance charge(balance connector required)
- STORAGE:** Storage charge/discharge(balance connector optional)
- CHARGE:** Normal charge (balance connector not required)
- DISCHARGE:** Discharge (balance connector optional)

Note: When working finished, disconnect the charge cable, along with "Bi...Bi...Bi..." sound, screen return to "STANDBY" menu.

CELL(S)

AUTO: Can be select in balance charge and storage mode, charger can automatically detect the cell count of the battery.

- 1: Charge/Discharge 1 cell battery(N/A in balance charge mode)
- 2: Charge/Discharge 2 cells battery
- 3: Charge/Discharge 2 cells battery
- 4: Charge/Discharge 4 cells battery
- 5: Charge/Discharge 5 cells battery
- 6: Charge/Discharge 6 cells battery

Important note: In non balance mode, charger can not detect the correct cell count of the battery which has voltage intersection with the other one. So the cell count you set must be exact the same as your battery, otherwise may cause dangerous situation.

CURRENT(A)

Setting the max charge/discharge current. Range from **0.5-10**, change unit: **0.5**

TVC(MV)

Terminal Voltage Control. Range from **3550-3650**, change unit: **10**, default: **4200**
(Storage mode range from 3200-3300, default: 3250)

SAVE [1]

Save the current setting to 1st-9th memory.

START

Connect the battery, press start, charger will work under current setting.

BACK

Back to "STANDBY" menu.

Working status specify

Balance Charge

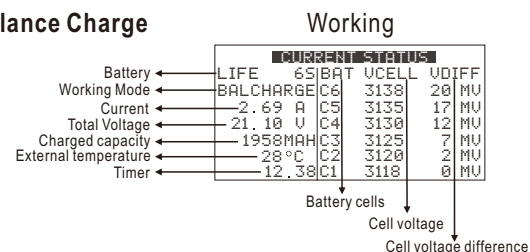

Storage

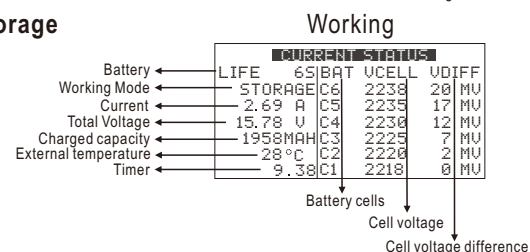

Charge

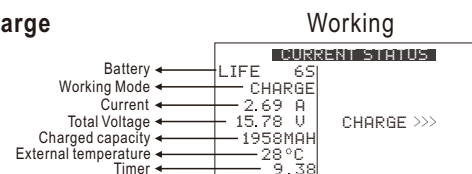

Discharge

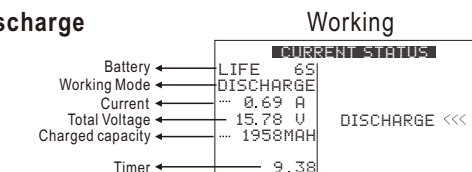

*Display stop along with "Bi...Bi..." sound

*Display stop along with "Bi...Bi..." sound

*Display stop along with "Bi...Bi..." sound

*Display stop along with "Bi...Bi..." sound

Note: When working finished, disconnect the charge cable, along with "Bi...Bi...Bi..." sound, screen return to "STANDBY" menu.

CHARGE/DISCHARGE LIIO BATTERY

***Select:** turn left/right
 ***Enter/Set:** press

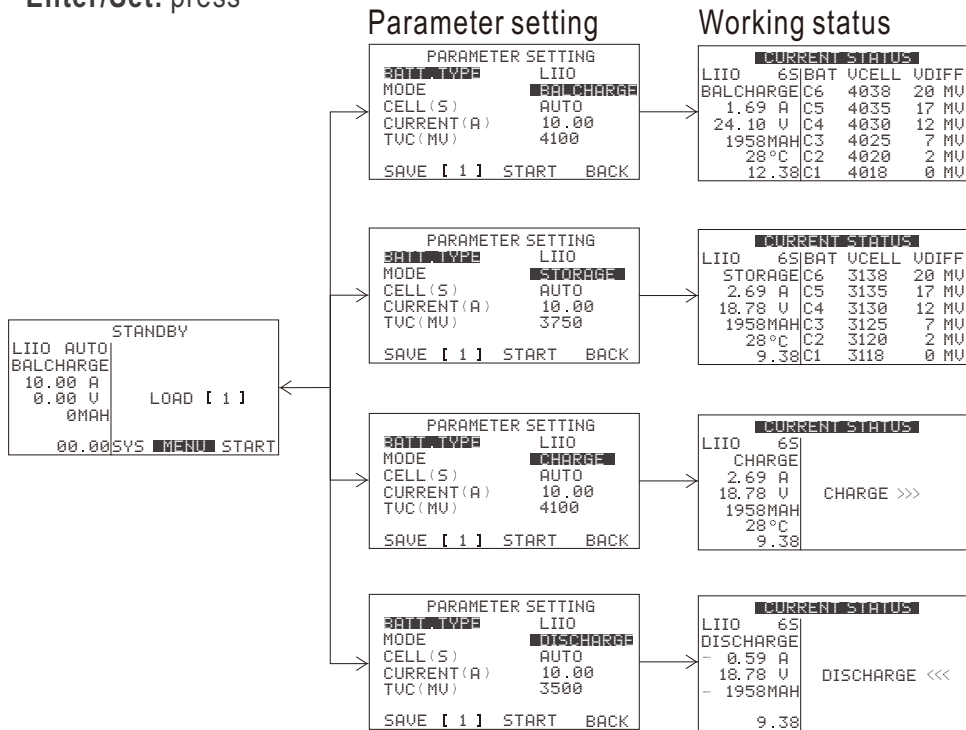

BATT.TYPE

LIIO

MODE

- BALCHARGE:** Balance charge(balance connector required)
- STORAGE:** Storage charge/discharge(balance connector optional)
- CHARGE:** Normal charge (balance connector not required)
- DISCHARGE:** Discharge (balance connector optional)

CELL(S)

AUTO: Can be select in balance charge and storage mode, charger can automatically detect the cell count of the battery.

- 1: Charge/Discharge 1 cell battery(N/A in balance charge mode)
- 2: Charge/Discharge 2 cells battery
- 3: Charge/Discharge 2 cells battery
- 4: Charge/Discharge 4 cells battery
- 5: Charge/Discharge 5 cells battery
- 6: Charge/Discharge 6 cells battery

Important note: In non balance mode, charger can not detect the correct cell count of the battery which has voltage intersection with the other one. So the cell count you set must be exact the same as your battery, otherwise may cause dangerous situation.

CURRENT(A)

Setting the max charge/discharge current. Range from **0.5-10**, change unit: **0.5**

TVC(MV)

Terminal Voltage Control. Range from **4050-4150**, change unit: **10**, default: **4200**
 (Storage mode range from **3700-3800**, default: **3750**)

SAVE [1]

Save the current setting to 1st-9th memory.

START

Connect the battery, press start, charger will work under current setting.

BACK

Back to "STANDBY" menu.

CHARGE/DISCHARGE NIMH BATTERY

Working status specify

Balance Charge

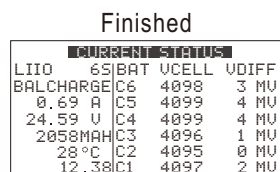
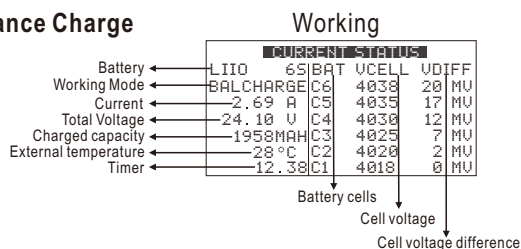

*Display stop along with "Bi...Bi..." sound

Storage

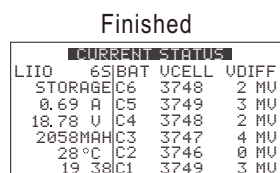
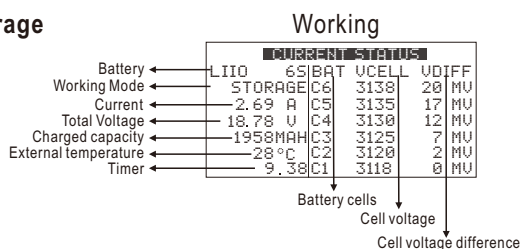

*Display stop along with "Bi...Bi..." sound

Charge

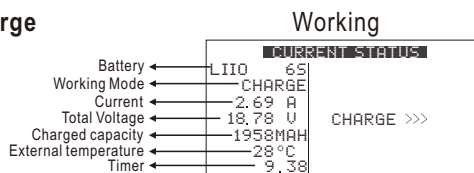

*Display stop along with "Bi...Bi..." sound

Discharge

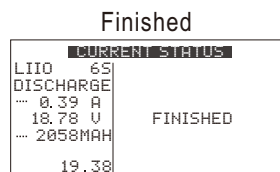
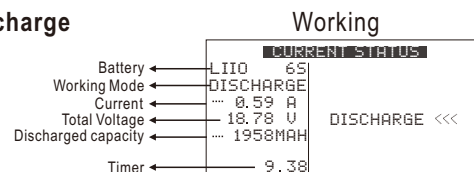

*Display stop along with "Bi...Bi..." sound

Note: When working finished, disconnect the charge cable, along with "Bi...Bi...Bi..." sound, screen return to "STANDBY" menu.

*Select: turn left/right

*Enter/Set: press

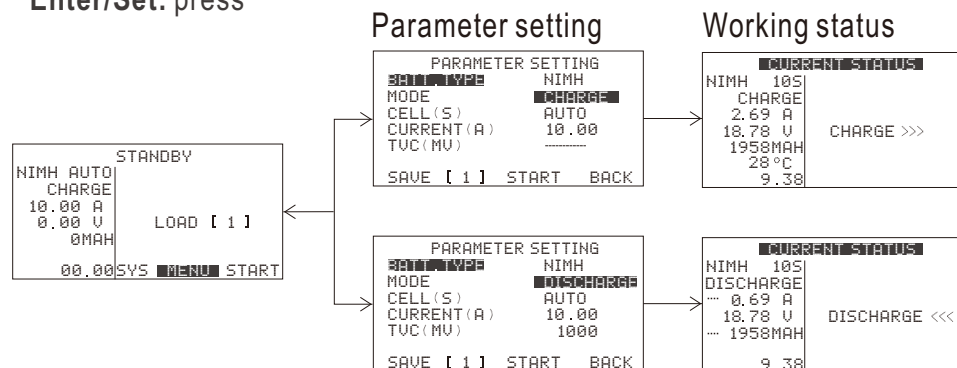

BATT.TYPE

NIMH

MODE

CHARGE: Charge
DISCHARGE: Discharge

CELL(S)

AUTO: Charger automatically detect the cell count of the battery.

- 1: Charge/Discharge 1 cell battery
- 2: Charge/Discharge 2 cells battery
- 3: Charge/Discharge 2 cells battery

15: Charge/Discharge 15 cells battery

Important note: Charger can not detect the correct cell count of the battery which has voltage intersection with the other one. So the cell count you set must be exact the same as your battery, otherwise may cause dangerous situation.

CHARGE/DISCHARGE NICD BATTERY

CURRENT(A)

Setting the max charge/discharge current. Range from **0.5-10**, change unit: **0.5**

TVC(MV)

Terminal Voltage Control. Only available in **discharge mode** Range from **800-1200**, change unit: **10**, default: **1000**

SAVE [1]

Save the current setting to 1st-9th memory.

START

Connect the battery, press start, charger will work under current setting.

BACK

Back to "STANDBY" menu.

***Select:** turn left/right

***Enter/Set:** press

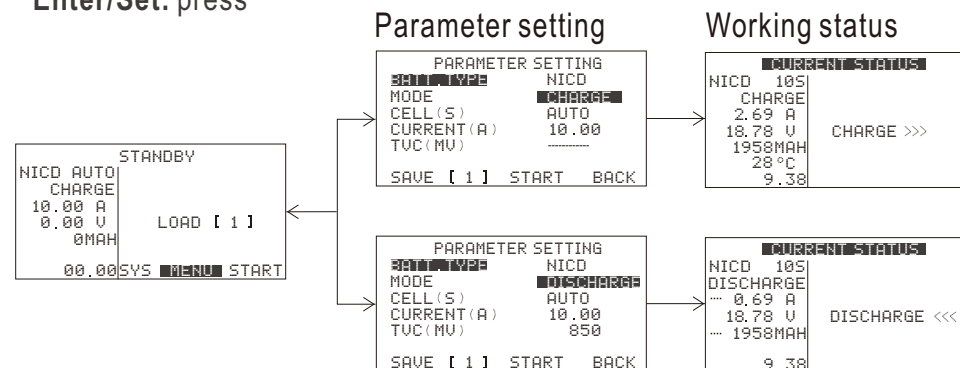

Working status specify

Charge

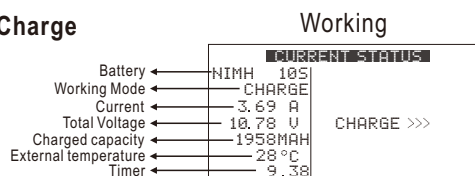

Finished



*Display stop along with "Bi...Bi..." sound

Discharge

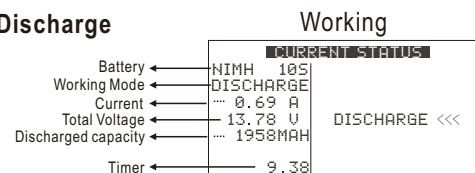

Finished

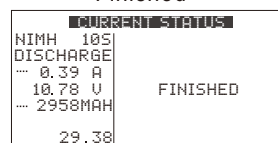

*Display stop along with "Bi...Bi..." sound

Note: When working finished, disconnect the charge cable, along with "Bi...Bi...Bi..." sound, screen return to "STANDBY" menu.

BATT.TYPE

NICD

MODE

CHARGE: Charge
DISCHARGE: Discharge

CELL(S)

AUTO: Charger automatically detect the cell count of the battery.

- 1: Charge/Discharge 1 cell battery
- 2: Charge/Discharge 2 cells battery
- 3: Charge/Discharge 2 cells battery

15: Charge/Discharge 15 cells battery

Important note: Charger can not detect the correct cell count of the battery which has voltage intersection with the other one. So the cell count you set must be exact the same as your battery, otherwise may cause dangerous situation.

CHARGE/DISCHARGE PB BATTERY

CURRENT(A)

Setting the max charge/discharge current. Range from **0.5-10**, change unit: **0.5**

TVC(MV)

Terminal Voltage Control. Only available in **discharge mode** Range from **650-1050**, change unit: **10**, default: **1000**

SAVE [1]

Save the current setting to 1st-9th memory.

START

Connect the battery, press start, charger will work under current setting.

BACK

Back to "STANDBY" menu.

***Select:** turn left/right

***Enter/Set:** press

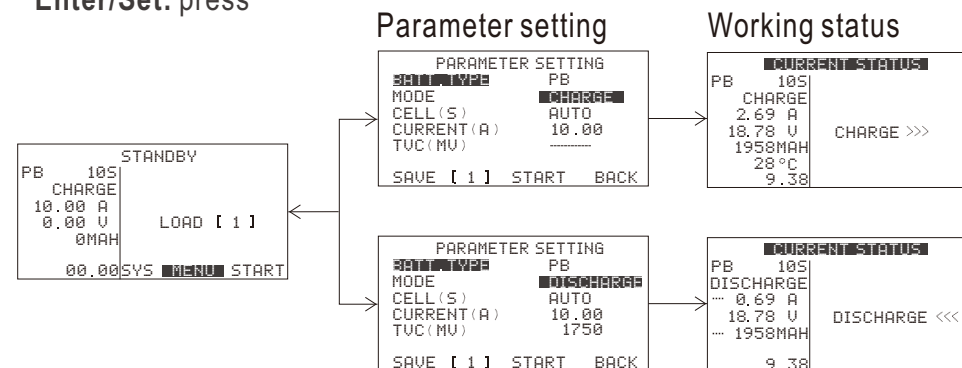

Working status specify

Charge

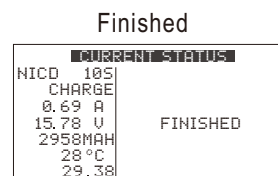
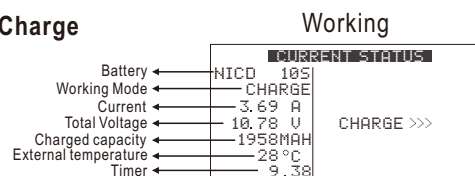

*Display stop along with "Bi...Bi..." sound

Discharge

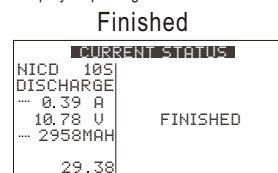
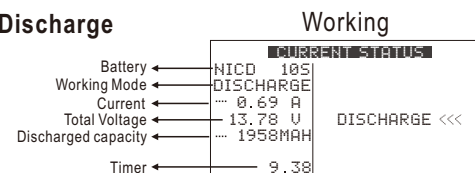

*Display stop along with "Bi...Bi..." sound

Note: When working finished, disconnect the charge cable, along with "Bi...Bi...Bi..." sound, screen return to "STANDBY" menu.

BATT.TYPE

PB

MODE

CHARGE: Charge
DISCHARGE: Discharge

CELL(S)

AUTO: Charger automatically detect the cell count of the battery.

- 1: Charge/Discharge 1 cell battery
- 2: Charge/Discharge 2 cells battery
- 3: Charge/Discharge 2 cells battery

10: Charge/Discharge 10cells battery

Important note: Charger can not detect the correct cell count of the battery which has voltage intersection with the other one. So the cell count you set must be exact the same as your battery, otherwise may cause dangerous situation.

NOTES OF WORK STATUS

CURRENT(A)

Setting the max charge/discharge current. Range from **0.5-10**, change unit: **0.5**

TVC(MV)

Terminal Voltage Control. Only available in **discharge mode** Range from **1550-1950**, change unit: **10**, default: **1750**

SAVE [1]

Save the current setting to 1st-9th memory.

START

Connect the battery, press start, charger will work under current setting.

BACK

Back to "STANDBY" menu.

Working status specify

Charge

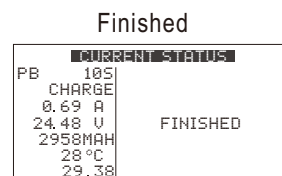
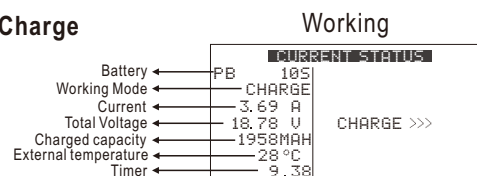

*Display stop along with "Bi...Bi..." sound

Discharge

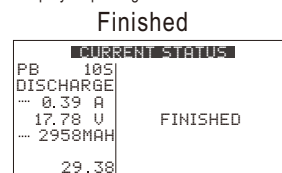
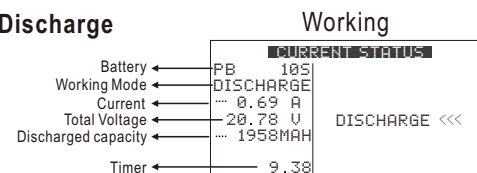

*Display stop along with "Bi...Bi..." sound

Note: When working finished, disconnect the charge cable, along with "Bi...Bi...Bi..." sound, screen return to "STANDBY" menu.

Note:

- 1, Press "START" or during working, if input voltage is higher than 18.0V, charger will display "HIGHER INPUT VOLTAGE" along with "Bi...Bi...Bi..." sound.
- 2, Press "START" or during working, if input voltage is lower than 11.0V, charger will display "LOWER INPUT VOLTAGE" along with "Bi...Bi...Bi..." sound.
- 3, If output connection reverse, charger will display "REVERSE OUTPUT" along with "Bi...Bi...Bi..." sound.
- 4, If battery's total voltage is lower than the discharge cutoff level, charger will display "LOWER TOTAL VOLTAGE" along with "Bi...Bi...Bi..." sound.
- 5, If battery's cell voltage is lower than the discharge cutoff level, charger will display "LOWER CELL VOLTAGE" along with "Bi...Bi...Bi..." sound.
- 6, If battery detected by the charger is different from your setting, charger MAY display "BATTERY ERROR" along with "Bi...Bi...Bi..." sound.
- 7, Disconnect the charge cable during working status, charger will display "CONNECTION ERROR" along with "Bi...Bi...Bi..." sound.
- 8, In "BALCHARGE" mode, disconnect the balance connector, charger will display "BALANCE ERROR" along with "Bi...Bi...Bi..." sound.
- 9, In "CHARGE" mode, plug in balance connector, charger will automatically shift to "Balance charge" mode. Disconnect the balance connector, charger will display "BALANCE ERROR" along with "Bi...Bi...Bi..." sound.
- 10, In "DISCHARGE" and "STORAGE" mode, plug in balance connector, charger will display cell voltage. Disconnect the balance connector, charger will display "BALANCE ERROR" along with "Bi...Bi...Bi..." sound.

Remark:

- 1, Once the charger report error, press "ENTER" to return "STANDBY" Menu.
- 2, Screen diagram shows in this manual only for reference, and will be different in each use.

BATTERY IN SERIES CHARGE

You can charge and balance several Lithium batteries at the same time, by using optional 2x2S(2x3S) in series adaptor. Please note that the battery packs being charged should have same capacity and cell-count.

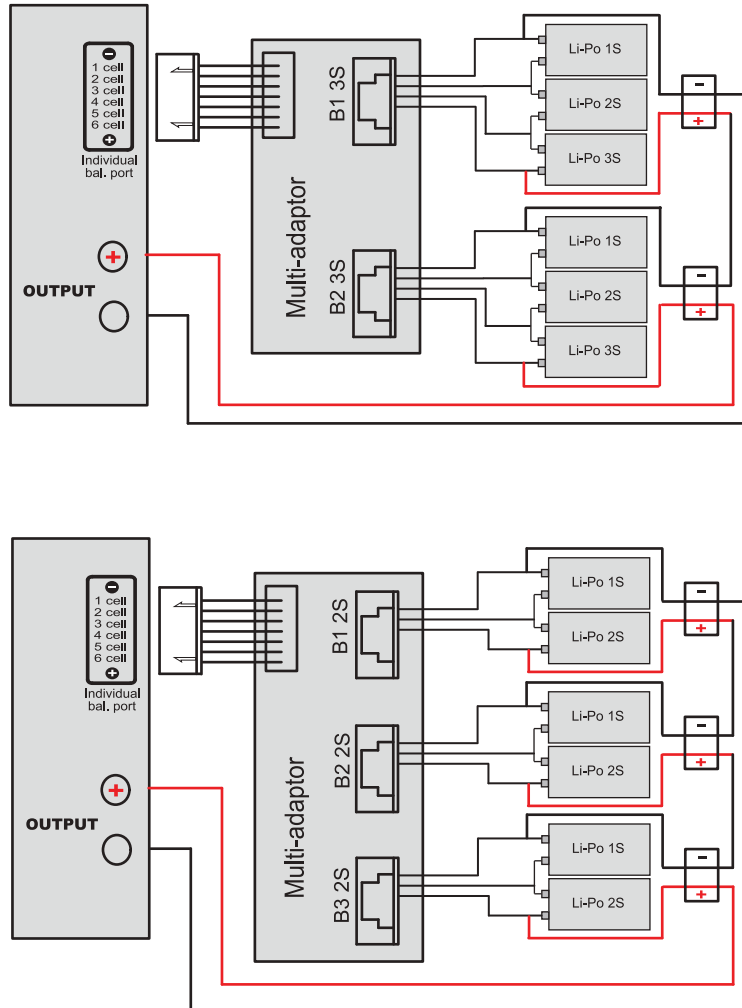

WARRANTY

CRC provide a period of one year product warranty from the date of purchase. The warranty only applies to material or operational defects, which are present at the time of purchase.

During that period, we will repair or replace free of service charge for products deemed defective due to those causes. This warranty is not valid for any damage or subsequent damage arising as a result of misuse, modification or as a result of failure to observe the use guideline in this manual.

LIABILITY EXCLUSION

C6P is designed and approved exclusively for charge the types of battery stated in this manual. CRC do not accept any liability if the charger is used for any purpose other than that stated. We are unable to ensure you follow the instructions come with the charger, and we have no control over the methods you employ for using, operating and maintaining this device. For this reason we are obliged to deny the liability for loss, damage or costs which are incurred due to the incompetent or incorrect use and operation of this product, or which are connected with such operation in any way. Unless otherwise prescribed by law, our obligation to pay compensation, regardless of the legal argument employed, is limited to the invoice value of those CRC products which were immediately and directly involved in the event in which the damage occurred.

CONFORMITY DECLARATION

C6P satisfies all relevant and mandatory EC directives and FCC Part 15 Subpart B: 2008.
The product has been tested to meet the following technical standards:

Application	Test Standard	Title	Result
CE-LVD	EN60335	For safety of household and similar electrical appliances.	Conform
CE-EMC	EN55014-1:2006	Electromagnetic compatibility-Requirements for household appliances,electric tools and Similar apparatus - Part 1: Emission	Conform
	EN55014-2:1997 +A1:2001	Electromagnetic compatibility-Requirements for household appliances,electric tools and Similar apparatus - Part 2: Immunity-Product family standard	Conform
	EN61000-6-1(2007)	Electromagnetic compatibility (EMC) -- Part 6-1: Generic standards - Immunity for residential, commercial and light-industrial environments.	Conform
	EN61000-6-3(2007)	Electromagnetic compatibility (EMC) -- Part 6-3: Genericstandards - Emission standard for residential, commercial andlight-industrial environments.	Conform
FCC-VOC	FCC Part 15B	Electromagnetic compatibility (EMC), Conduction Emission & Radiation Emission	Conform

CRC PRODUCT SUMMARY

C6S 10A/80W DC



C6P 10A/100W DC



This symbol means that you must dispose of electrical devices from the general household waste when it reaches the end of its useful life. Take your charger to your local waste collection point or recycling centre.
This applies to all countries of the European Union, and to other European countries with a separate waste collection system.

SHENZHEN CASAL TECHNOLOGY CO.,LTD